

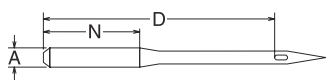





















記号 SYSTEM SYSTEM SISTEMA 型號	他社記号 OTHER MAKER SYSTEM PARALLELSYSTEME SISTEMAS EQUIVALENTES 其他公司型號	先端 POINT SPITZ PUNTA 針尖	ミシン針イラスト ILLUSTRATION OF NEEDLE NADELFOTO FOTO DE AGUJA 縫紉機針示意圖	用途 APPLICATION ANMERKUNG NOTAS 用途	番手 NEEDLE SIZES NADELSTÄRKEN TAMAÑOS DE AGUJAS 針號
■ 本縫い関係 For Lockstitch 平縫系列					
DB × 1	16 × 231 16 × 257		 A:1.62~2.02 D:33.80 N:16.00~10.50	本縫い lockstitch	7 8 9 10 11 12 13 14 16 18 19 20 21 22 22½ 23 24 25 55 60 65 70 75 80 85 90 100 110 120 125 130 140 150 160 180 200
DB × 1KN			 A:1.62 D:33.80 N:16.00	ニット用 for knitted fabrics	8 9 10 11 12 14 60 65 70 75 80 90
DB × 1KNLE			 A:1.62 D:33.80 N:16.00	DB × 1 KNの糸穴大 DB × 1 KN with large needle eye	9 10 11 12 65 70 75 80
DB × 1SF			 A:1.62 D:33.80 N:16.00	超ファインゲージニット用 for very fine knitted fabrics	8 9 10 11 60 65 70 75
DB × 1NS			 A:1.62 D:33.80 N:16.00~10.50	新合織用 for new synthetic materials	8 9 10 11 12 14 60 65 70 75 80 90
DB × 1 - NY2			 A:1.62~1.90 D:33.80 N:16.00~12.50	目飛び対策針 preventing skipped stitches	9 10 11 12 14 16 18 19 65 70 75 80 90 100 110 120
DB × 1PR			 A:1.62 D:33.80 N:16.00	プリント生地用 for printed fabrics	10 11 70 75
DB × 1738	1738		 A:1.62~2.02 D:33.80 N:16.00~11.50	本縫い lockstitch	8 9 10 11 12 13 14 16 18 19 20 21 22 23 24 60 65 70 75 80 85 90 100 110 120 125 130 140 160 180
DB × 95			 A:1.62 D:33.80 N:13.50	本縫い用一段伸線 lockstitch (single-swaged blade)	8 9 10 11 12 13 14 16 17 18 19 20 21 22 23 24 60 65 70 75 80 85 90 100 105 110 120 125 130 140 160 180
DB × A20	287WK SY6633		 A:1.62 D:33.80 N:12.50~10.50	A寸=1.62mm (shank diameter = 1.62mm)	19 20 21 22 23 120 125 130 140 160
DB × 287WKH			 A:1.63 D:33.90 N:16.00	DB × 1のF寸短 DB × 1 with shorter distance from tip of the point to end of needle eye	7 8 9 10 11 12 13 14 16 18 19 21 55 60 65 70 75 80 85 90 100 110 120 130
DB × 1KK	1738KK		 A:1.62 D:33.80 N:12.50	DB × 1のN寸短 DB × 1 with shorter shank	11 14 16 75 90 100
DA × 1	88 × 1 SY1315		 A:1.62 D:29.60 N:14.50	本縫い lockstitch	7 8 9 10 11 12 13 14 16 18 19 20 21 22 55 60 65 70 75 80 85 90 100 110 120 125 130 140
DA × 1KN			 A:1.62 D:29.60 N:13.50	ニット用 for knitted fabrics	8 9 10 11 60 65 70 75
DI × 3			 A:1.98 D:39.20~39.00 N:14.50	靴、袋物縫用 for shoes, bags, etc	12 14 16 18 19 20 21 22 22½ 23 24 25 80 90 100 110 120 125 130 140 150 160 180 200
DP × 17	135 × 17		 A:2.00 D:39.00 N:16.00~13.00	本縫厚物用 for thick materials	9 10 11 12 13 14 16 18 19 20 21 22 23 24 25 26 65 70 75 80 85 90 100 110 120 125 130 140 160 180 200 230
DP × 17 - NY2			 A:2.00 D:39.00 N:16.00~13.00	目飛び対策針 preventing skipped stitches	11 12 14 16 18 19 20 21 22 23 75 80 90 100 110 120 125 130 140 160

上記以外にも様々な種類の針があります。詳しくは、お問い合わせください。/Please Note: we have many other types of needles that are not indicated above. Please contact us for details.

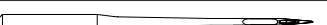
記号 SYSTEM SYSTEM SISTEMA 型號	他社記号 OTHER MAKER SYSTEM PARALLELSYSTEME SISTEMAS EQUIVALENTES 其他公司型號	先端 POINT SPITZ PUNTA 針尖	ミシン針イラスト ILLUSTRATION OF NEEDLE NADELFOTO FOTO DE AGUJA 縫紉機針示意圖 	用途 APPLICATION ANMERKUNG NOTAS 用途	番手 NEEDLE SIZES NADELSTÄRKEN TAMAÑOS DE AGUJAS 針號
DP - C80 - NY2			 A:2.00 D:39.00 N:13.00~16.00	DP × 17 - NY2の平取針 DP×17 - NY2 with flat shank	18 19 21 22 23 110 120 130 140 160
DP - C119 - NY2			 A:2.00 D:39.00 N:13.00	DP × 17 - NY2の平取針 DP×17 - NY2 with flat shank	19 22 23 120 140 160
DP × 17 - SK1			 A:2.00 D:39.00 N:16.00~13.50	目飛び対策針 preventing skipped stitches	14 16 18 19 20 21 22 23 24 90 100 110 120 125 130 140 160 180
DP × 17SF			 A:2.00 D:39.00 N:16.00	超ファインゲージニット用 for very fine knitted fabrics	9 10 65 70
DP × 17NS			 A:2.00 D:39.00 N:16.00	針穴跡防止 preventing poor needle hole	14 90
DP × 17LE			 A:2.00 D:39.00 N:16.00	DP × 17の糸穴大 DP × 17 with large needle eye	14 16 18 19 21 22 23 90 100 110 120 130 140 160
DP × 35R			 A:2.00 D:38.20 N:13.50	本縫玉縁用 lockstitch welting	8 9 10 11 12 13 14 16 18 19 20 21 22 22½ 23 23½ 24 25 60 65 70 75 80 85 90 100 110 120 125 130 140 150 160 170 180 200
DP × 35R - NY2			 A:2.00 D:38.20 N:13.50	目飛び対策針 preventing skipped stitches	14 16 18 19 20 21 22 23 90 100 110 120 125 130 140 160
DP - C126 - NY2			 A:2.00 D:38.20 N:13.50	DP × 35R - NY2の平取針 DP × 35R - NY2 with flat shank	18 19 21 22 110 120 130 140
DP × 35R - SK1			 A:2.00 D:38.20 N:13.50	目飛び対策針 preventing skipped stitches	14 16 18 19 20 21 22 23 90 100 110 120 125 130 140 160
DP - N45			 A:2.00 D:39.00 N:19.00	DP × 17の地糸切れ対策針 DP × 17 preventing fabric yarn breakage	18 110

■ 刺繍関係 For Embroidery 刺繍系列

DB × K5			 A:1.62~1.90 D:33.80 N:16.00~12.50	刺繍用 (DB×1の糸穴大) embroidery (DB × 1 with large needle eye)	8 9 10 11 12 13 14 16 18 19 60 65 70 75 80 85 90 100 110 120
DB × K5 - NY			 A:1.62 D:33.80 N:16.00	強度対策針 DB × K5 with reinforced blade	8 9 10 11 12 14 60 65 70 75 80 90
DB × K5 - YORI			 A:1.62 D:33.80 N:16.50	上糸切れ・ルーピング preventing upper thread breakage and poor embroidery stitches appearance	8 9 10 11 60 65 70 75
DB × K5Z1			 A:1.62 D:33.80 N:16.00	刺繍用 for multi-head embroidery machine	8 9 10 11 12 14 60 65 70 75 80 90
DB × K5Z1 - NY			 A:1.62 D:33.80 N:16.50	刺繍用強度対策針 DB × K5Z1 with reinforced blade	9 10 11 12 14 65 70 75 80 90
DB × K5Z2 - NY			 A:1.62 D:33.80 N:13.50	刺繍 厚物、円筒枠用 for cylindrical frame, thick materials	9 10 11 12 14 65 70 75 80 90

上記以外にも様々な種類の針があります。詳しくは、お問い合わせください。/Please Note: we have many other types of needles that are not indicated above. Please contact us for details.

記号 SYSTEM SYSTEM SISTEMA 型號	他社記号 OTHER MAKER SYSTEM PARALLELSYSTEME SISTEMAS EQUIVALENTES 其他公司型號	先端 POINT SPITZ PUNTA 針尖	ミシン針イラスト ILLUSTRATION OF NEEDLE NADELFOTO FOTO DE AGUJA 縫紉機針示意圖	用途 APPLICATION ANMERKUNG NOTAS 用途	番手 NEEDLE SIZES NADELSTÄRKEN TAMAÑOS DE AGUJAS 針號
DB × K5Q1				刺繍用 for multi-head embroidery machine	8 9 10 11 12 14 60 65 70 75 80 90
DB × K5KK				DB × K5のN寸短 DB × K5 with shorter shank	9 10 11 12 14 65 70 75 80 90
DB × 5ST				DB × 1 の糸穴大 DB × 1 with large needle eye	16 20 22 100 125 140
DB × 7ST				DB × 1 の糸穴大 DB × 1 with large needle eye	9 11 12 14 16 18 65 75 80 90 100 110
DB × 9ST				DB × 1 の糸穴大 DB × 1 with large needle eye	9 11 14 16 18 65 75 90 100 110
PH - C70				ハンドル刺繍用 for chenille embroidery	11 14 16 18 19 21 75 90 100 110 120 130
PH - C70LE				ハンドル刺繍用 for chenille embroidery	14 16 90 100
PH × 1				ハンドル刺繍用 for chenille embroidery	9 11 12 13 14 15 16 18 19 20 21 22 23 26 65 75 80 85 90 95 100 110 120 125 130 140 160 230
PH × 1SM				ハンドル刺繍用 for chenille embroidery	14 16 18 19 90 100 110 120
PH × 1TR				ハンドル刺繍用 for chenille embroidery	12 14 16 18 19 80 90 100 110 120
PH × 1WS				ハンドル刺繍用 for chenille embroidery	14 16 90 100

■ ボタン付け関係 For Button sewing 釘扣系列

TQ × 1	29 - S 175 × 1 1985			ボタン付け button sewing	9 10 11 12 13 14 16 18 19 20 21 22 65 70 75 80 85 90 100 110 120 125 130 140
TQ × 3	175 × 3 1661LG			ボタン付け button sewing	11 12 14 16 18 19 20 21 22 75 80 90 100 110 120 125 130 140
TQ × 7	29 - L 175 × 7 2091			ボタン付け button sewing	9 10 11 12 13 14 16 18 19 20 21 22 23 65 70 75 80 85 90 100 110 120 125 130 140 160
TQ × 7KK				TQ × 7のN寸短 TQ × 7 with shorter shank	10 12 14 16 18 19 20 21 22 70 80 90 100 110 120 125 130 140
TQ × 9	29 - LSS 175 × 9			ボタン付け button sewing	9 10 11 12 14 16 18 19 20 21 22 65 70 75 80 90 100 110 120 125 130 140
TQ × 13	175 × 13			ボタン付け button sewing	13 16 18 20 22 85 100 110 125 140











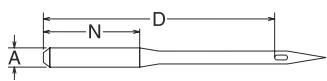









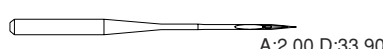









上記以外にも様々な種類の針があります。詳しくは、お問い合わせください。/Please Note: we have many other types of needles that are not indicated above. Please contact us for details.

記号 SYSTEM SYSTEM SISTEMA 型號	他社記号 OTHER MAKER SYSTEM PARALLELSYSTEME SISTEMAS EQUIVALENTES 其他公司型號	先端 POINT SPITZ PUNTA 針尖	ミシン針イラスト ILLUSTRATION OF NEEDLE NADEL FOTO FOTO DE AGUJA 縫紉機針示意圖	用途 APPLICATION ANMERKUNG NOTAS 用途	番手 NEEDLE SIZES NADELSTÄRKEN TAMAÑOS DE AGUJAS 針號
SM × 332LG	332LGHKSP			ボタン付け button sewing	11 12 14 16 18 19 21 22 23 75 80 90 100 110 120 130 140 160
SM × 332EXTLG	332EXT LG			ボタン付け button sewing	9 10 11 12 14 16 18 65 70 75 80 90 100 110
SM × 332EXTLG - NY				SM × 332EXTLG with reinforced blade 強度対策針	11 12 14 16 18 75 80 90 100 110
SM × 332SUPLG				ボタン付け button sewing	12 14 16 80 90 100
DPN - 2000A	2000A			根巻ボタン付用 button sewing (button-neck-wrapping)	38 49 100 115
DP - N29				ボタン付け DP × 17 N寸短 button sewing DP×17 with shorter shank	11 14 75 90
DP × 17KK				ボタン付け DP × 17 N寸短 button sewing DP×17 with shorter shank	11 14 75 90

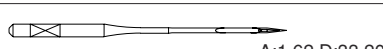

■ 千鳥縫い関係 (穴かがり、閉止用) For Zigzag stitching, Buttonholing and Bartacking 曲折縫 鎖眼 套結系列

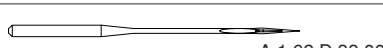
DP × 5	134R 135 × 5 797			穴かがり・千鳥縫用 buttonholing, zigzag stitching	7 8 9 10 11 12 13 14 16 18 19 20 21 22 22½ 23 23½ 24 25 55 60 65 70 75 80 85 90 100 110 120 125 130 140 150 160 170 180 200
DP × 5KN				ニット用 for knitted fabrics	8 9 10 11 12 60 65 70 75 80
DP × 5SF				超ファインゲージニット用 for very fine knitted fabrics	9 10 11 65 70 75
DP × 5NS				新合繊用 for new synthetic materials	8 9 10 11 12 14 60 65 70 75 80 90
DP × 134 - NY2				目飛び対策針 preventing skipped stitches	9 10 11 12 14 16 18 19 20 21 22 23 65 70 75 80 90 100 110 120 125 130 140 160
DP × 134 - SK1				目飛び対策針 preventing skipped stitches	14 16 18 19 20 21 22 23 90 100 110 120 125 130 140 160
DP × 134HS				熱対策針 preventing needle heat	10 11 12 14 16 18 22 70 75 80 90 100 110 140
PF × 134KK				DP × 5のN寸短 DP × 5 with shorter shank	8 10 11 12 13 14 16 18 19 21 22 60 70 75 80 85 90 100 110 120 130 140
DP × 1	135 × 1 354			本縫い lockstitch	8 9 10 11 12 13 14 16 18 19 20 21 22 22½ 23 24 25 60 65 70 75 80 85 90 100 110 120 125 130 140 150 160 180 200
DP × 58				千鳥縫用 zigzag stitching	9 10 11 12 14 16 18 19 65 70 75 80 90 100 110 120





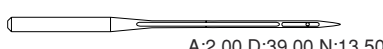

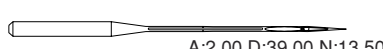



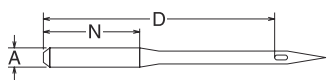



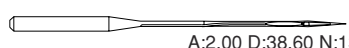

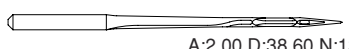

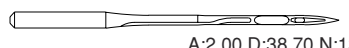





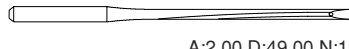

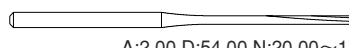

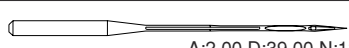

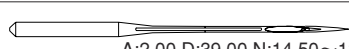



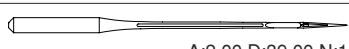

上記以外にも様々な種類の針があります。詳しくは、お問い合わせください。/Please Note: we have many other types of needles that are not indicated above. Please contact us for details.

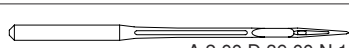
記号 SYSTEM SYSTEM SISTEMA 型號	他社記号 OTHER MAKER SYSTEM PARALLELSYSTEME SISTEMAS EQUIVALENTES 其他公司型號	先端 POINT SPITZ PUNTA 針尖	ミシン針イラスト ILLUSTRATION OF NEEDLE NADELFOTO FOTO DE AGUJA 縫紉機針示意圖 	用途 APPLICATION ANMERKUNG NOTAS 用途	番手 NEEDLE SIZES NADELSTÄRKEN TAMAÑOS DE AGUJAS 針號
DP × 265	265 - 50EO 438 - 80EO		 A:2.00 D:34.00 N:13.50	ファンデーション用 for underwear	10 11 12 14 16 18 19 70 75 80 90 100 110 120
DP × 438	265 438		 A:2.00 D:33.90 N:13.50	本縫千鳥用 lockstitch, zigzag stitching	8 9 10 11 12 14 16 18 19 60 65 70 75 80 90 100 110 120
DP × 438KK			 A:2.00 D:33.90 N:11.50	DP × 438のN寸短 DP × 438 with shorter shank	10 12 14 16 18 19 70 80 90 100 110 120
DP - G65			 A:2.00 D:33.90 N:12.50	ファンデーション用 (DP × 5 スリムUボール) for underwear (DP × 5 with slim U-ball point)	9 10 11 65 70 75
DP × 134LE			 A:2.00 D:33.90 N:12.50	飾りステッチ用 (DP × 5 糸穴大) decoration stitch (DP×5 with large needle eye)	9 10 11 12 14 16 18 19 21 22 23 65 70 75 80 90 100 110 120 130 140 160
SG × 1906	135 × 53 SY1906		 A:2.00 D:33.90 N:13.50~11.50	千鳥縫用 ファンデーション用 zigzag stitching, for underwear	8 9 10 11 12 13 14 16 18 19 20 21 60 65 70 75 80 85 90 100 110 120 125 130
SG × 1963	SY1963		 A:2.00 D:33.90 N:13.50	千鳥縫用 ファンデーション用 zigzag stitching, for underwear	8 9 10 11 12 60 65 70 75 80
SG × 1965	SY1965		 A:2.00 D:33.90 N:13.50	千鳥縫用 ファンデーション用 zigzag stitching, for underwear	9 10 11 12 14 65 70 75 80 90
DO × 5	142 × 5 SY1413		 A:2.02 D:31.30 N:10.00	鳩目穴かがり用 eyelet buttonholing	11 12 14 16 18 19 20 21 22 75 80 90 100 110 120 125 130 140
DO × 5 - NY			 A:2.02 D:31.30 N:10.00	強度対策針 DO × 5 with reinforced blade	16 18 19 100 110 120
DO × 558	558		 A:2.00 D:33.90 N:11.00	鳩目穴かがり用 eyelet buttonholing	10 11 12 14 16 18 19 21 70 75 80 90 100 110 120 130
DO × 558 - NY2			 A:2.00 D:33.90 N:11.00	目飛び対策針 preventing skipped stitches	12 14 16 18 19 80 90 100 110 120
EB × 750	750 (SC)		 A:1.62 D:33.20 N:12.50	穴かがり門止用 buttonholing, bartacking	8 9 10 11 12 14 16 18 19 20 21 22 60 65 70 75 80 90 100 110 120 125 130 140
EB × 755	501 (SC) 755H 1807 1807D		 A:1.62 D:33.00 N:12.00	鳩目穴かがり用 eyelet buttonholing	8 9 10 11 12 14 16 18 19 20 21 23 60 65 70 75 80 90 100 110 120 125 130 160
EB × 755NS			 A:1.62 D:33.00 N:12.00	新合繊用 for new synthetic materials	11 12 14 75 80 90

■ 二重環縫い関係 For Double chainstitch 雙鏈縫系列

DV × 1	UY121GS 759 1628 MY1001		 A:2.00 D:39.00 N:13.50 (E:46.00~43.70)	平2本二重環縫用 2-needle double chainstitch	7 8 9 10 11 12 13 14 16 18 19 20 21 22 23 24 25 55 60 65 70 75 80 85 90 100 110 120 125 130 140 160 180 200
DV × 43	62 × 43		 A:2.00 D:39.00 N:13.50 (E:44.90~44.70)	二重環縫用 #19以上=TV × 3 double chainstitch over#19=TV × 3	9 10 11 12 13 14 16 18 65 70 75 80 85 90 100 110

上記以外にも様々な種類の針があります。詳しくは、お問い合わせください。/Please Note: we have many other types of needles that are not indicated above. Please contact us for details.

記号 SYSTEM SYSTEM SISTEMA 型號	他社記号 OTHER MAKER SYSTEM PARALLELSYSTEME SISTEMAS EQUIVALENTES 其他公司型號	先端 POINT SPITZ PUNTA 針尖	ミシン針イラスト ILLUSTRATION OF NEEDLE NADELFOTO FOTO DE AGUJA 縫紉機針示意圖 	用途 APPLICATION ANMERKUNG NOTAS 用途	番手 NEEDLE SIZES NADELSTÄRKEN TAMAÑOS DE AGUJAS 針號
DV × G9			 A:2.00 D:39.00 N:13.50 (E:44.80~44.50)	DV × 43 エグリ付き DV × 43 with scarf	8 9 11 12 13 14 60 65 75 80 85 90
DV × 57	62 × 57 5640		 A:2.00 D:38.60 N:13.00 (E:44.20)	厚物二重環縫用 溝ひねり針 for thick materials (twist groove)	9 10 11 12 13 14 16 18 19 20 21 22 22½ 23 24 25 65 70 75 80 85 90 100 110 120 125 130 140 150 160 180 200
DV × 57 - NY2			 A:2.00 D:38.60 N:13.00 (E:44.20)	DV × 57の目飛び対策針 DV × 57 for preventing skipped stitches	18 19 20 21 22 110 120 125 130 140
DV × 57LE			 A:2.00 D:38.70 N:13.00 (E:44.70)	DV × 57の糸穴大 DV × 57 with large needle eye	16 18 19 20 21 22 24 100 110 120 125 130 140 180
DV × 57LE - NY2			 A:2.00 D:38.60 N:13.00 (E:44.20)	DV × 57LEの目飛び対策針 DV × 57LE for preventing skipped stitches	18 19 110 120
DV × 59	62 × 59		 A:2.00 D:41.50 N:13.00 (E:48.50)	厚物二重環縫用 溝ひねり針 for thick materials (twist groove)	14 16 18 19 20 21 22 23 24 25 90 100 110 120 125 130 140 160 180 200
DV × 210			 A:2.00 D:49.00 N:13.00 (E:56.00)	キルティング用 for quilting	21 22 23 24 130 140 160 180
DV × 600			 A:2.00 D:54.00 N:20.00~17.00 (E:63.00)	キルティング用 for quilting	14 18 21 23 24 90 110 130 160 180
DV × 63	B - 63		 A:2.00 D:39.00 N:13.50 (E:43.70)	2本針 3本針 二重環縫用 2 or 3-needle double chainstitch	7 8 9 10 11 12 13 14 16 18 19 20 21 22 23 55 60 65 70 75 80 85 90 100 110 120 125 130 140 160
UY × 128GAS	UY128GAS MY1040		 A:2.00 D:39.00 N:14.50~13.50 (E:44.80~44.60)	平2~3本針 2 or 3-needle double chainstitch	7 8 9 10 11 12 13 14 16 18 19 20 21 22 22½ 23 23½ 25 55 60 65 70 75 80 85 90 100 110 120 125 130 140 150 160 170 200
UY × 128GASKN			 A:2.00 D:39.00 N:14.50 (E:44.80~44.60)	ニット用 for knitted fabrics	7 8 9 10 11 12 55 60 65 70 75 80
UY × 128KK			 A:2.00 D:39.00 N:12.00 (E:44.70)	UY × 128GASのN寸短 UY × 128GAS with shorter shank	7 8 9 10 11 55 60 65 70 75
UY × 128KK - KN			 A:2.00 D:39.00 N:12.00 (E:44.80)	UY × 128GASKNのN寸短 UY × 128GASKN with S short shank	8 9 60 65
UY × 128GAS - NY2			 A:2.00 D:39.00 N:14.50 (E:44.70)	目飛び対策針 preventing skipped stitches	7 8 9 10 11 12 14 16 18 19 20 21 22 55 60 65 70 75 80 90 100 110 120 125 130 140
UY × 128GAS - SK1			 A:2.00 D:39.00 N:14.50~13.50 (E:44.70)	目飛び対策針 preventing skipped stitches	16 18 19 20 21 100 110 120 125 130
UY × 128LE			 A:2.00 D:39.00 N:14.50 (E:44.70)	UY × 128GASの糸穴大 UY × 128GAS with large needle eye	8 9 10 11 14 16 18 19 21 23 60 65 70 75 90 100 110 120 130 160
UY × 128FL			 A:2.00 D:39.00 N:14.50 (E:44.70)	UY × 128GASの平取針 UY × 128GAS with flat shank	8 9 10 60 65 70
DV - C65			 A:2.00 D:39.00 N:14.50 (E:44.70)	UY × 128GASの平取針 UY × 128GAS with flat shank	8 9 10 11 60 65 70 75

上記以外にも様々な種類の針があります。詳しくは、お問い合わせください。/Please Note: we have many other types of needles that are not indicated above. Please contact us for details.

記号 SYSTEM SYSTEM SISTEMA 型號	他社記号 OTHER MAKER SYSTEM PARALLELSYSTEME SISTEMAS EQUIVALENTES 其他公司型號	先端 POINT SPITZ PUNTA 針尖	ミシン針イラスト ILLUSTRATION OF NEEDLE NADELFOTO FOTO DE AGUJA 縫紉機針示意圖 	用途 APPLICATION ANMERKUNG NOTAS 用途	番手 NEEDLE SIZES NADELSTÄRKEN TAMAÑOS DE AGUJAS 針號
TV × 1	149 × 1		 A:2.00 D:37.00 N:13.50 (E:41.90~41.60)	へム縫、伏せ縫用 hemming, felled seam	7 8 9 10 11 12 13 14 16 18 19 20 21 22 23 55 60 65 70 75 80 85 90 100 110 120 125 130 140 160
TV × 3	149 × 3 UY124GS		 A:2.00 D:39.00 N:13.50 (E:45.00)	脇縫用 #18以下=DV×43 for side seam #18 and under=DV×43	19 20 21 22 23 24 120 125 130 140 160 180
TV × 5	149 × 5 62 × 53		 A:2.00 D:41.40 N:13.50 (E:47.40~46.50)	伏せ縫用 felled seam	8 9 10 11 12 13 14 16 18 19 20 21 22 23 24 25 60 65 70 75 80 85 90 100 110 120 125 130 140 160 180 200
TV × 5 - SK2			 A:2.00 D:41.40 N:13.50 (E:46.70)	目飛び対策針 preventing skipped stitches	12 80
TV × 5HS			 A:2.00 D:41.40 N:13.50 (E:47.20~47.00)	熱対策針 preventing needle heat	18 19 21 110 120 130
TV × 7	149 × 7 MY1002A		 A:2.00 D:37.00 N:13.50 (E:42.80~42.50)	へム縫、伏せ縫用 hemming, felled seam	8 9 10 11 12 13 14 16 17 18 19 20 21 22 23 24 25 60 65 70 75 80 85 90 100 105 110 120 125 130 140 160 180 200
TV × 7HS			 A:2.00 D:37.00 N:13.50 (E:42.80~42.30)	熱対策針 preventing needle heat	14 16 18 90 100 110
TV × 64	B - 64		 A:2.00 D:36.60 N:13.50 (E:41.60~41.10)	伏せ縫用 felled seam	8 9 10 11 12 13 14 16 18 19 20 21 22 23 25 60 65 70 75 80 85 90 100 110 120 125 130 140 160 200
UO × 113GS	UY113GS		 A:2.00 D:36.60 N:14.50~13.50 (E:41.50)	スモッキング等 二重環縫い smocking, double chainstitch	8 9 10 11 12 13 14 16 18 19 20 21 22 23 60 65 70 75 80 85 90 100 110 120 125 130 140 160
UO × 113GS-NY2			 A:2.00 D:36.60 N:13.50 (E:41.50)	目飛び対策針 preventing skipprd stitches	14 90
UO × 163	UY163GAS		 A:2.00 D:37.50 N:13.50 (E:43.90)	ピコット縫用 for picot stitch	8 9 10 11 12 13 14 16 18 19 21 22 22½ 60 65 70 75 80 85 90 100 110 120 130 140 150
UO × 163GAS	UY163GAS SY7185		 A:2.00 D:37.50 N:13.50 (E:43.90)	ピコット縫用 for picot stitch	11 12 14 16 18 19 20 75 80 90 100 110 120 125
UY × 121	UY121GS MY1001 759		 A:2.00 D:39.00 N:13.50 (E:43.70)	平2本二重環縫用 2-needle double chainstitch	7 8 9 10 11 12 13 14 16 18 19 20 21 22 23 55 60 65 70 75 80 85 90 100 110 120 125 130 140 160
UY × 121GBS	UY121GBS		 A:2.00 D:39.00 N:14.50~13.50 (E:43.70)	平2本二重環縫用 2-needle double chainstitch	9 10 11 12 14 16 18 19 21 65 70 75 80 90 100 110 120 130
SM × 1014A	MY1014A		 A:1.48 D:39.00 N:15.50 (E:44.20)	4本針偏平縫用 4-needle interlock stitch	8 9 10 11 12 14 60 65 70 75 80 90
SM × 1014B	MY1014B		 A:1.48 D:39.00 N:15.50 (E:44.20)	4本針偏平縫用 エグリ付き 4-needle interlock stitch (with scarf)	8 9 10 11 12 14 16 18 60 65 70 75 80 90 100 110
SM × 1014H	MY1014H		 A:1.48 D:39.00 N:15.50 (E:43.80)	4本針偏平縫用 目飛び対策針 4-needle interlock stitch preventing skipped stitches	9 10 11 12 65 70 75 80

上記以外にも様々な種類の針があります。詳しくは、お問い合わせください。/Please Note: we have many other types of needles that are not indicated above. Please contact us for details.

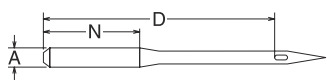
記号 SYSTEM SYSTEM SISTEMA 型號	他社記号 OTHER MAKER SYSTEM PARALLELSYSTEME SISTEMAS EQUIVALENTES 其他公司型號	先端 POINT SPITZ PUNTA 針尖	ミシン針イラスト ILLUSTRATION OF NEEDLE NADELFOTO FOTO DE AGUJA 縫紉機針示意圖 	用途 APPLICATION ANMERKUNG NOTAS 用途	番手 NEEDLE SIZES NADELSTÄRKEN TAMAÑOS DE AGUJAS 針號
---	--	-------------------------------------	---	---	---

■ フラットシーマー関係 For Flat seamer 多針鏈縫系列

FL × 118A	UY118GAS		 A:1.51 D:36.60 N:16.50	フラットシーマー flat seamer	8 9 10 11 12 14 16 18 60 65 70 75 80 90 100 110
FL × 118GBS	UY118GBS		 A:1.51 D:36.60 N:16.50	フラットシーマー flat seamer	8 9 10 11 12 14 16 60 65 70 75 80 90 100
FL × 118GCS	UY118GKS		 A:1.51 D:36.60 N:16.50	フラットシーマー エグリ付き flat seamer with scarf	8 9 10 11 12 60 65 70 75 80
FL × 118GCS - NY2			 A:1.51 D:36.60 N:16.50	FL × 118GCSの目飛び対策針 FL × 118GCS preventing skipped stitches	9 10 11 65 70 75
FL × 118GCSSF			 A:1.51 D:36.60 N:16.50	超ファインゲージニット用 for very fine knitted fabrics	9 10 11 65 70 75
FL × 118KK			 A:1.51 D:36.60 N:15.50	FL × 118GCSのN寸短 FL × 118GCS with shorter shank	9 10 11 65 70 75
FL × 118 - SK2			 A:1.51 D:36.60 N:16.50	目飛び対策針 preventing skipped stitches	8 9 10 11 60 65 70 75
FLG - 1			 A:1.51 (E:41.20) N:15.00	フラットシーマー リテーナ針 retainer needle	7 8 9 10 11 12 55 60 65 70 75 80
FLG - 8			 A:1.51 (E:41.20) N:15.00	フラットシーマー リテーナ針エグリ付 retainer needle with scarf	8 60

■ オーバーロック関係 For Overlock 包縫系列

DC × 1	81 × 1 MY1023A 621		 A:2.02 D:28.60 N:10.00	オーバーロック用 overlock (～#11=J ball)	6 7 8 9 10 11 12 13 14 16 18 19 20 21 22 23 24 25 50 55 60 65 70 75 80 85 90 100 110 120 125 130 140 160 180 200
DC × 1NS			 A:2.02 D:28.60 N:10.00	新合繊用 for new synthetic materials	8 9 10 11 12 60 65 70 75 80
DC × 1KN			 A:2.02 D:28.60 N:10.00	ニット用 for knitted fabrics	8 9 10 11 12 14 60 65 70 75 80 90
DC × 1SF			 A:2.02 D:28.60 N:10.00	超ファインゲージニット用 for very fine knitted fabrics	8 9 10 11 60 65 70 75
DC × 3	SY8358		 A:1.22 D:28.50 N:13.00	まつり縫い用 2本針オーバーロック blind stitch, 2-needle overlock	7 8 9 10 11 12 13 14 16 18 19 20 21 22 55 60 65 70 75 80 85 90 100 110 120 125 130 140
DC × 3KN			 A:1.22 D:28.60 N:13.00	ニット用 for knitted fabrics	9 10 11 65 70 75
DC × 27	B - 27 MY1023		 A:2.02 D:28.60 N:10.00	オーバーロック用 (～#11=J ball) overlock	6 7 8 9 10 11 12 13 14 16 18 19 20 21 22 23 24 50 55 60 65 70 75 80 85 90 100 110 120 125 130 140 160 180

上記以外にも様々な種類の針があります。詳しくは、お問い合わせください。/Please Note: we have many other types of needles that are not indicated above. Please contact us for details.

記号 SYSTEM SYSTEM SISTEMA 型號	他社記号 OTHER MAKER SYSTEM PARALLELSYSTEME SISTEMAS EQUIVALENTES 其他公司型號	先端 POINT SPITZ PUNTA 針尖	ミシン針イラスト ILLUSTRATION OF NEEDLE NADELFOTO FOTO DE AGUJA 縫紉機針示意圖	用途 APPLICATION ANMERKUNG NOTAS 用途	番手 NEEDLE SIZES NADELSTÄRKEN TAMAÑOS DE AGUJAS 針號
DC - C47				両面平取 flat shank on both sides	9 10 11 12 13 16 18 65 70 75 80 85 100 110
DC × 27LE				DC × 27の糸穴大 DC × 27 with large needle eye	11 14 16 75 90 100
DC - N17	81 × 1 621 MY1023A			DC × 1 N寸=13mm shank length = 13mm	7 8 9 10 11 12 13 14 16 18 19 20 21 22 55 60 65 70 75 80 85 90 100 110 120 125 130 140
DC - N17SF				超ファインゲージニット用 for very fine knitted fabrics	9 10 65 70
DC - N24				DC × 27 N寸=13mm shank length = 13mm	11 14 75 90
DC - N25				DC × 1 N寸=11.50mm shank length = 11.50mm	7 8 9 10 11 55 60 65 70 75
DC - N25SF				超ファインゲージニット用 for very fine knitted fabrics	9 65
DM × 13	82 × 13 1886KK			DC × 1のN寸短 (～#11=J ball) DC × 1 with shorter shank	7 8 9 10 11 12 13 14 16 18 19 20 21 22 23 24 55 60 65 70 75 80 85 90 100 110 120 125 130 140 160 180
DM × 13KN				DC × 1KNのN寸短 DC × 1KN with shorter shank	9 10 11 65 70 75







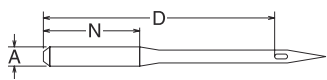



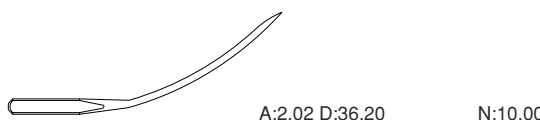

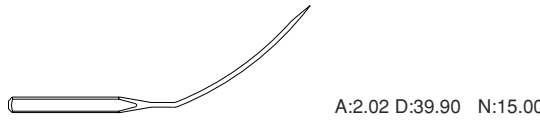

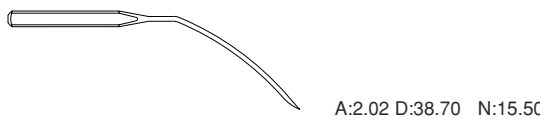
■ 曲げ針オーバーロック関係 For Curved overlock needle 彎針包縫系列

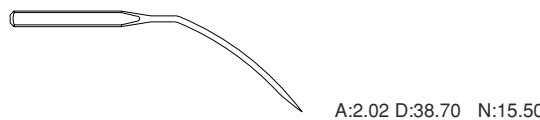
UN × 154	UY8454GS			曲針オーバーロック curved overlock needle	7 8 9 10 11 12 13 14 16 18 21 55 60 65 70 75 80 85 90 100 110 130
UN - R7				曲針オーバーロック 両面平取 curved overlock needle (flat shank on both sides)	9 11 14 65 75 90
UN - R12				曲針オーバーロック 両面平取 curved overlock needle (flat shank on both sides)	9 11 14 65 75 90
UO × 154				曲針オーバーロック curved overlock needle	7 8 9 10 11 12 13 14 16 18 19 20 22 55 60 65 70 75 80 85 90 100 110 120 125 140
UY × 154GAS	UY154GAS SY1431			曲針オーバーロック 片面平取 curved overlock needle (flat shank on one side)	7 8 9 10 11 12 14 16 18 19 20 21 22 55 60 65 70 75 80 90 100 110 120 125 130 140
UY × 154GBS	UY154GBS SY6430			曲針オーバーロック 片面平取 curved overlock needle (flat shank on one side)	9 10 11 12 14 16 18 65 70 75 80 90 100 110
UY × 154GCS	UY154GCS SY6431			曲針オーバーロック 両面平取 curved overlock needle (flat shank on both sides)	9 10 11 12 14 16 65 70 75 80 90 100
MR - R9				メローオーバーロック用 for merrow overlock	8 9 10 11 12 13 14 16 18 19 21 22½ 60 65 70 75 80 85 90 100 110 120 130 150

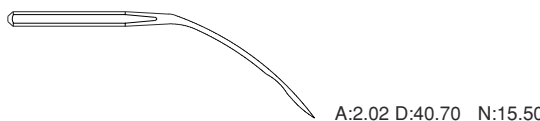

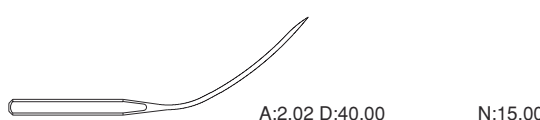
上記以外にも様々な種類の針があります。詳しくは、お問い合わせください。/Please Note: we have many other types of needles that are not indicated above. Please contact us for details.

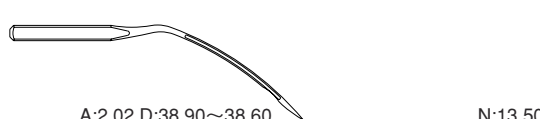
記号 SYSTEM SYSTEM SISTEMA 型號	他社記号 OTHER MAKER SYSTEM PARALLELSYSTEME SISTEMAS EQUIVALENTES 其他公司型號	先端 POINT SPITZ PUNTA 針尖	ミシン針イラスト ILLUSTRATION OF NEEDLE NADELFOTO FOTO DE AGUJA 縫紉機針示意圖 	用途 APPLICATION ANMERKUNG NOTAS 用途	番手 NEEDLE SIZES NADELSTÄRKEN TAMAÑOS DE AGUJAS 針號
---	--	-------------------------------------	---	---	---

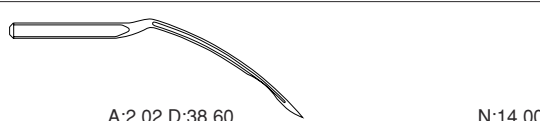
■ マツリ、スクイ縫い関係 For Blind stitch 暗縫系列

LW × 1T	29 - 12		 A:2.02 D:36.20 N:10.00	伏せ縫 マツリ縫用 felled seam, blind stitch	8 9 10 11 12 14 16 18 19 21 60 65 70 75 80 90 100 110 120 130
LW × 2T	29 - 34		 A:2.02 D:39.90 N:15.00	伏せ縫 マツリ縫用 felled seam, blind stitch	8 9 10 11 12 13 14 16 18 19 21 60 65 70 75 80 85 90 100 110 120 130
LW × 3T	29 - C - 300		 A:2.02 D:38.70 N:15.50	盲縫 マツリ縫用 blind stitch	8 9 10 11 12 13 14 16 18 19 20 21 22 60 65 70 75 80 85 90 100 110 120 125 130 140
LW × 4T	29 - C - 300		 A:2.02 D:38.70 N:15.50	盲縫 マツリ縫用 blind stitch	8 9 11 12 14 16 60 65 75 80 90 100
LW × 5T	29 - C - 300LG		 A:2.02 D:40.70 N:15.50	奥マツリ用 blind stitch	0 5 10 15 20 25 30 35 40 45 50 65 70 75 80 85 90 95 100 105 110 120
LW × 6T	29 - 34		 A:2.02 D:40.00 N:15.00	伏せ縫 マツリ縫用 felled seam, blind stitch	7 8 9 10 11 12 13 14 16 18 19 1½ 2 2½ 3 3½ 4 4½ 5 55 60 65 70 75 80 85 90 100 110 120
LW × 1669E	1669E		 A:2.02 D:38.90~38.60 N:13.50	ハザシ用 for lapel padding and collar	8 9 10 11 12 13 14 16 18 19 21 60 65 70 75 80 85 90 100 110 120 130
LW × 1669E EO	1669E EO		 A:2.02 D:38.60 N:14.00	ハザシ用 for lapel padding and collar	8 9 10 12 14 16 60 65 70 80 90 100

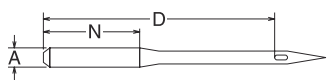
上記以外にも様々な種類の針があります。詳しくは、お問い合わせください。/Please Note: we have many other types of needles that are not indicated above. Please contact us for details.

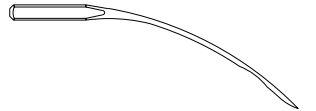
記号 SYSTEM SYSTEM SISTEMA 型號	他社記号 OTHER MAKER SYSTEM PARALLELSYSTEME SISTEMAS EQUIVALENTES 其他公司型號	先端 POINT SPITZ PUNTA 針尖	ミシン針イラスト ILLUSTRATION OF NEEDLE NADEL FOTO FOTO DE AGUJA 縫紉機針示意圖 	用途 APPLICATION ANMERKUNG NOTAS 用途	番手 NEEDLE SIZES NADELSTÄRKEN TAMAÑOS DE AGUJAS 針號
LW - C5	29 - 39		 A:2.02 D:36.20 N:10.00	伏せ縫 マツリ縫用 felled seam, blind stitch LW×1Tの逆平取針	8 9 10 11 12 14 16 18 19 21 60 65 70 75 80 90 100 110 120 130











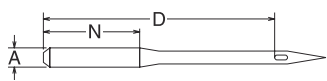

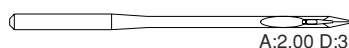





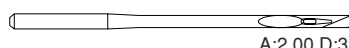







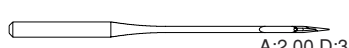



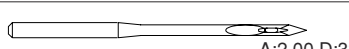

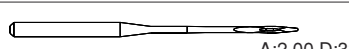

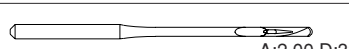

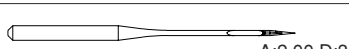
■ ハンドステッチ関係 For Hand stitch 仿手工縫系列

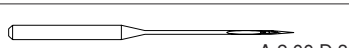
CP × 1	29 - C - 150 SY1902		 A:2.02 D:34.50 N:18.00	星飾り縫い・ピンポイント用 pinpoint and decoration stitch	14 16 18 19 21 22 90 100 110 120 130 140
CP × 1J			 A:2.02 D:34.50 N:18.00	星飾り縫い・ピンポイント用 pinpoint and decoration stitch	14 16 18 19 21 22 90 100 110 120 130 140
CP × 2			 A:2.02 D:34.50 N:14.00	星飾り縫い・ピンポイント用 pinpoint and decoration stitch	14 16 18 19 21 22 23 90 100 110 120 130 140 160
CP × 12	29 - C - 151 151 151S		 A:2.02 N:18.00	星飾り縫い・ピンポイント用 pinpoint and decoration stitch	11 12 14 16 18 19 20 21 22 23 75 80 90 100 110 120 125 130 140 160
CP × 12J			 A:2.02 N:18.00	星飾り縫い・ピンポイント用 pinpoint and decoration stitch	19 20 21 22 23 120 125 130 140 160
CP × 13			 A:2.02 N:14.00	星飾り縫い・ピンポイント用 pinpoint and decoration stitch	9 11 12 14 16 18 19 20 21 22 23 65 75 80 90 100 110 120 125 130 140 160
CP × 17			 A:2.02 N:12.50	星飾り縫い・ピンポイント用 pinpoint and decoration stitch	11 14 16 18 19 21 75 90 100 110 120 130
CP × 170			 A:2.02 N:12.50	星飾り縫い・ピンポイント用 pinpoint and decoration stitch	14 16 18 19 21 90 100 110 120 130
CP × 200			 A:2.02 D:34.50 N:14.00	星飾り縫い・ピンポイント用 pinpoint and decoration stitch	14 16 18 19 90 100 110 120
DPN - 1032B			 A:1.00 (E:44.40)	ハンドステッチ用 for hand stitch	32 38 49 80 100 115











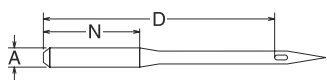

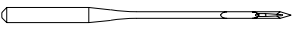

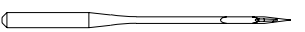





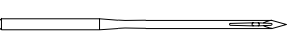

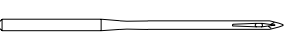
■ レザー針関係 For Leather 皮革系列

DB × F2	1738LR		 A:1.62~2.02 D:33.80 N:16.00~10.50	皮革用 for leather	9 11 12 13 14 16 18 19 20 21 22 23 24 25 65 75 80 85 90 100 110 120 125 130 140 160 180 200
DB × F17	1738S		 A:1.62~1.90 D:33.80 N:16.00~12.50	皮革用 for leather	8 9 10 11 12 14 16 18 19 60 65 70 75 80 90 100 110 120
DP × 8	134DIA		 A:2.00 D:33.90 N:14.50~11.50	皮革用 for leather	10 12 14 16 18 19 20 21 22 23 24 70 80 90 100 110 120 125 130 140 160 180
DP × 16	135 × 16NW		 A:2.00 D:39.00 N:13.50	皮革用 for leather	12 14 16 18 19 20 21 22 23 24 25 80 90 100 110 120 125 130 140 160 180 200

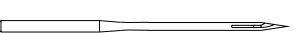
上記以外にも様々な種類の針があります。詳しくは、お問い合わせください。/Please Note: we have many other types of needles that are not indicated above. Please contact us for details.

記号 SYSTEM SYSTEM SISTEMA 型號	他社記号 OTHER MAKER SYSTEM PARALLELSYSTEME SISTEMAS EQUIVALENTES 其他公司型號	先端 POINT SPITZ PUNTA 針尖	ミシン針イラスト ILLUSTRATION OF NEEDLE NADEL FOTO FOTO DE AGUJA 縫紉機針示意圖 	用途 APPLICATION ANMERKUNG NOTAS 用途	番手 NEEDLE SIZES NADELSTÄRKEN TAMAÑOS DE AGUJAS 針號
DP × 16DIA	135 × 16DIA		 A:2.00 D:39.00 N:13.50	皮革用 for leather	16 18 19 20 21 22 23 24 25 100 110 120 125 130 140 160 180 200
DP × 16LR	135 × 16RTW		 A:2.00 D:39.00 N:13.50	皮革用 for leather	19 20 21 22 23 24 120 125 130 140 160 180
DP × 16N	135 × 16TW		 A:2.00 D:39.00 N:13.50	皮革用 for leather	20 21 22 23 125 130 140 160
DP × 17LBR			 A:2.00 D:39.00 N:13.00	皮革用 for leather	23 160
DP × 17LR			 A:2.00 D:39.00 N:16.00~13.00	皮革用 for leather	14 16 18 19 20 21 22 23 24 90 100 110 120 125 130 140 160 180
DP × 17S			 A:2.00 D:39.00 N:16.00~13.00	皮革用 for leather	14 16 18 19 20 21 22 23 90 100 110 120 125 130 140 160
DP × 35LL	134 - 35LL		 A:2.00 D:38.20 N:13.50	皮革用 for leather	12 14 16 18 19 21 22 25 80 90 100 110 120 130 140 200
DP × 35LR	134 - 35LR		 A:2.00 D:38.20 N:13.50	皮革用 for leather	10 12 14 16 18 19 20 21 22 22½ 23 24 25 70 80 90 100 110 120 125 130 140 150 160 180 200
DP × 35PCL	134 - 35PCL		 A:2.00 D:38.20 N:13.50	皮革用 for leather	10 12 14 16 18 19 21 70 80 90 100 110 120 130
PF × 134D	134D		 A:2.00 D:33.90 N:14.50~11.50	皮革用 for leather	8 10 11 12 13 14 16 18 19 20 21 22 22½ 23 24 25 60 70 75 80 85 90 100 110 120 125 130 140 150 160 180 200
PF × 134KS	134S		 A:2.00 D:33.90 N:14.50~11.50	皮革用 for leather	9 10 11 12 13 14 16 18 19 21 22 22½ 23 25 65 70 75 80 85 90 100 110 120 130 140 150 160 200
PF × 134LBR			 A:2.00 D:33.90 N:14.50~11.50	皮革用 for leather	18 21 110 130
PF × 134LL	134LL		 A:2.00 D:33.90 N:14.50~11.50	皮革用 for leather	10 11 12 13 14 16 18 19 21 22 23 24 70 75 80 85 90 100 110 120 130 140 160 180
PF × 134LR	134LR		 A:2.00 D:33.90 N:14.50~11.50	皮革用 for leather	7 8 9 10 11 12 13 14 16 18 19 20 21 22 22½ 23 24 25 55 60 65 70 75 80 85 90 100 110 120 125 130 140 150 160 180 200
PF × 134P	134P		 A:2.00 D:33.90 N:14.50~11.50	皮革用 for leather	10 11 12 13 14 16 18 19 20 21 22 23 70 75 80 85 90 100 110 120 125 130 140 160
PF × 134PCL	134PCL		 A:2.00 D:33.90 N:14.50~11.50	皮革用 for leather	8 9 10 11 12 13 14 16 18 19 20 21 22 22½ 23 24 25 60 65 70 75 80 85 90 100 110 120 125 130 140 150 160 180 200
PF × 134PCR	134PCR		 A:2.00 D:33.90 N:14.50~11.50	皮革用 for leather	10 11 12 13 14 16 18 19 21 22 70 75 80 85 90 100 110 120 130 140
PF × 134VR			 A:2.00 D:33.90 N:14.50~11.50	皮革用 for leather	14 16 18 19 21 22 90 100 110 120 130 140



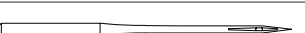







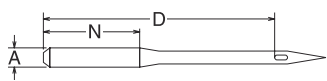



上記以外にも様々な種類の針があります。詳しくは、お問い合わせください。/Please Note: we have many other types of needles that are not indicated above. Please contact us for details.

記号 SYSTEM SYSTEM SISTEMA 型號	他社記号 OTHER MAKER SYSTEM PARALLELSYSTEME SISTEMAS EQUIVALENTES 其他公司型號	先端 POINT SPITZ PUNTA 針尖	ミシン針イラスト ILLUSTRATION OF NEEDLE NADEL FOTO FOTO DE AGUJA 縫紉機針示意圖 	用途 APPLICATION ANMERKUNG NOTAS 用途	番手 NEEDLE SIZES NADELSTÄRKEN TAMAÑOS DE AGUJAS 針號
PF × 134KKD			 A:2.00 D:33.90 N:11.50	PF × 134DのN寸短 PF × 134D with shorter shank	11 14 16 18 75 90 100 110
PF × 134KKLR			 A:2.00 D:33.90 N:11.50	PF × 134LRのN寸短 PF × 134LR with shorter shank	9 10 11 12 14 16 18 65 70 75 80 90 100 110
PF × 134KKPCL			 A:2.00 D:33.90 N:11.50	PF × 134PCLのN寸短 PF × 134PCL with shorter shank	9 10 11 12 14 16 18 65 70 75 80 90 100 110
TF × 2	34LL		 A:1.62/1.90/2.02 D:33.80 N:13.50~10.50	皮革用 for leather	7 8 9 10 11 12 13 14 16 18 19 20 21 22 23 24 25 55 60 65 70 75 80 85 90 100 110 120 125 130 140 160 180 200
TF × 2D	34DIA		 A:1.62/1.90/2.02 D:33.80 N:13.50~10.50	皮革用 for leather	8 9 10 11 12 14 16 18 19 20 21 22 60 65 70 75 80 90 100 110 120 125 130 140
TF × 2LR	34LR		 A:1.62/1.90/2.02 D:33.80 N:13.50~10.50	皮革用 for leather	7 8 9 10 11 12 13 14 16 18 19 20 21 22 23 24 25 55 60 65 70 75 80 85 90 100 110 120 125 130 140 160 180 200
TF × 4	34PCL		 A:1.62/1.90/2.02 D:33.80 N:13.50~11.00	皮革用 for leather	8 9 10 11 12 13 14 16 18 19 20 21 60 65 70 75 80 85 90 100 110 120 125 130
TF × 6	34PCR		 A:1.62/1.90/2.02 D:33.85 N:13.50~11.00	皮革用 for leather	8 9 10 11 12 13 14 16 18 19 20 21 22 23 24 60 65 70 75 80 85 90 100 110 120 125 130 140 160 180
TF × F8	SY2078 34S		 A:1.62/1.90/2.02 D:33.80 N:13.50~10.50	皮革用 for leather	7 8 9 10 11 12 14 16 18 19 21 22 55 60 65 70 75 80 90 100 110 120 130 140
DP × F22	134KKS		 A:2.00 D:33.90 N:12.50~11.50	皮革用 for leather	9 10 11 12 14 16 18 19 20 21 22 23 65 70 75 80 90 100 110 120 125 130 140 160
PF × 34P	34P		 A:1.62 D:34.00 N:13.50	皮革用 for leather	10 11 12 13 14 16 18 70 75 80 85 90 100 110

■ 家庭用ミシン関係 For Home sewing machine 家庭用針系列

HA × 1	15 × 1 130/705H		 A:2.02 D:33.80 N:11.70	家庭用ミシン針 for home sewing machine	7 8 9 10 11 12 13 14 16 18 19 20 21 22 23 55 60 65 70 75 80 85 90 100 110 120 125 130 140 160
HA × 1DE			 A:2.02 D:33.80 N:11.70	デニム用 for denim	16 100
HA × 1GT			 A:2.02 D:33.80 N:11.70	ジョーゼット用 for georgette	7 55
HA × 1LL	15 × 2NTW 130LL 130/705HLL		 A:2.02 D:33.80 N:11.70	レザー用 for leather	11 14 16 75 90 100
HA × 1SP			 A:2.02 D:33.80 N:11.70	ニット用 for knitted fabrics	9 11 12 14 65 75 80 90
HA × 1QU			 A:2.02 D:33.80 N:11.70	キルト用 for quilting	11 14 75 90

上記以外にも様々な種類の針があります。詳しくは、お問い合わせください。/Please Note: we have many other types of needles that are not indicated above. Please contact us for details.

記号 SYSTEM SYSTEM SISTEMA 型號	他社記号 OTHER MAKER SYSTEM PARALLELSYSTEME SISTEMAS EQUIVALENTES 其他公司型號	先端 POINT SPITZ PUNTA 針尖	ミシン針イラスト ILLUSTRATION OF NEEDLE NADEL FOTO FOTO DE AGUJA 縫紉機針示意圖 	用途 APPLICATION ANMERKUNG NOTAS 用途	番手 NEEDLE SIZES NADELSTÄRKEN TAMAÑOS DE AGUJAS 針號
HA × 1EB			 A:2.02 D:33.80 N:11.70	刺繍用 for embroidery	11 14 75 90
HA × 1BR			 A:2.02 D:33.80 N:12.50~11.70	家庭用ミシン針 for home sewing machine	9 11 14 16 65 75 90 100
EL × 705			 A:2.02 D:33.90 N:11.50	家庭用ロック針 for home overlock	11 12 14 75 80 90
BL × 1			 A:1.62 D:33.80 N:13.50	ベビーロック職業用 for babylock	9 10 11 12 14 16 65 70 75 80 90 100
HL × 5			 A:2.00 D:33.90 N:12.50	家庭用ロック針 for home overlock	9 10 11 12 14 16 18 20 65 70 75 80 90 100 110 125
DC × 1F			 A:2.02 D:28.60 N:10.00	ベビーロック用 (DC × 1の平取針) babylock (DC × 1 with flat shank)	9 11 12 14 16 18 65 75 80 90 100 110
DC - C87			 A:2.02 D:28.60 N:10.00	ベビーロック用 (DC × 1KNの平取針) babylock (DC × 1KN with flat shank)	9 10 11 12 14 65 70 75 80 90

上記以外にも様々な種類の針があります。詳しくは、お問い合わせください。/Please Note: we have many other types of needles that are not indicated above. Please contact us for details.